

Sanki



φ58金皿用(PET)



φ58金皿用(PP)



φ54金皿用



No.17金皿用



No.6金皿用



φ48金皿用



No.19チーク金皿用



No.13チーク金皿用

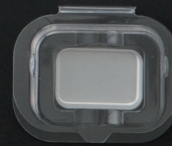

No.13シャドー金皿用

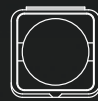

φ58  
金皿用(PET)



φ58  
金皿用(PP)

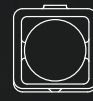

φ54  
金皿用



No.17  
金皿用



No.6  
金皿用



φ48  
金皿用



No.19チーク  
金皿用



No.13チーク  
金皿用



No.13シャドー  
金皿用

COMPACT  
リファillケース(金皿用)

14

MAKE UP  
SERIES

since 2013



# コンパクト リフィルケース(金皿用)

14  
MAKE UP  
SERIES

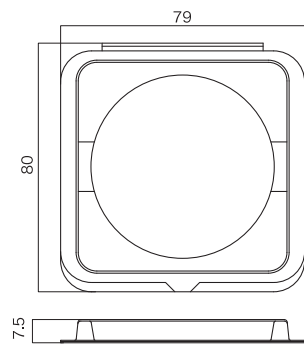

1 φ58金皿用(PET)

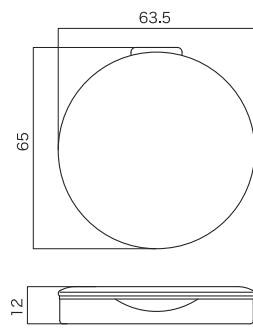

2 φ58金皿用(PP)

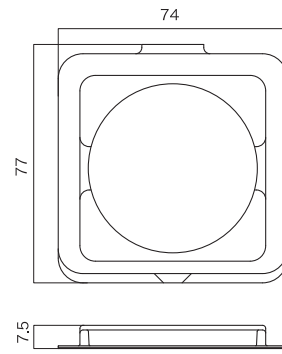

3 φ54金皿用

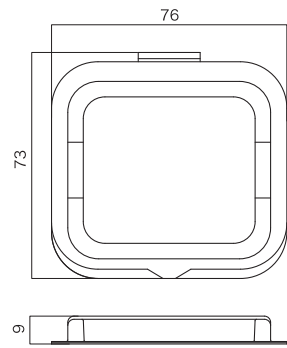

4 No.17金皿用

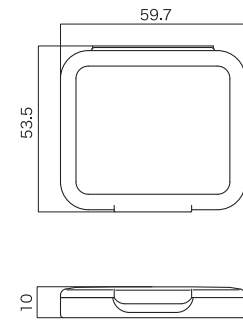

5 No.6金皿用

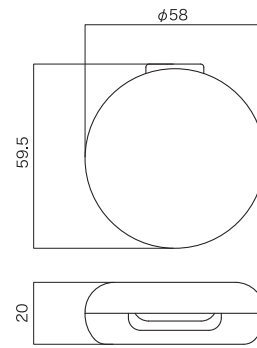

6 φ48金皿用

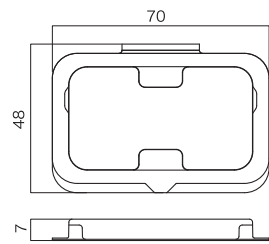

7 No.19チーク金皿用

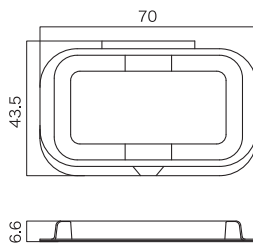

8 No.13チーク金皿用

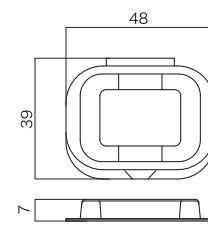

9 No.13シャドー金皿用

	製品名	材質	対応樹脂皿・アルミ皿	備考
1	φ58金皿用(PET)リフィルケース	PET	φ58×5t金皿	
2	φ58金皿用(PP)リフィルケース	PP	φ58×5t金皿	
3	φ54金皿用リフィルケース	PET	φ54×4.5t金皿	
4	No.17金皿用リフィルケース	PET	47×55×5t金皿	
5	No.6金皿用リフィルケース	PP	47×55×5t金皿	
6	φ48金皿用リフィルケース	PP	φ48×5t金皿	鏡有・無
7	No.19チーク金皿用リフィルケース	PET	50×24.5×4t金皿	
8	No.13チーク金皿用リフィルケース	PET	49×22×4.5t金皿	
9	No.13シャドー金皿用リフィルケース	PET	25×17×4t金皿	

※状況に応じて内容を変更する場合があります。