

Sanki



通気穴 有



No.17(L)1パーツ



通気穴 無



No.17(L)2パーツ



No.17(S)1パンA



No.17(S)1パンB



No.17(S)2パン



No.17(S)3パン



No.17(S)



No.17(L)

COMPACT
コンパクト

12
MAKE UP
SERIES

since 2013



コンパクト

No.17(L)、No.17(S)

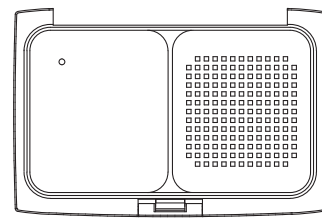
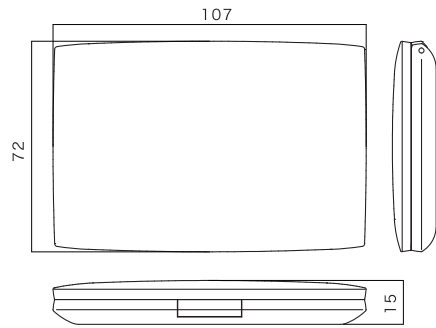

1 No.17(L)1パーツ

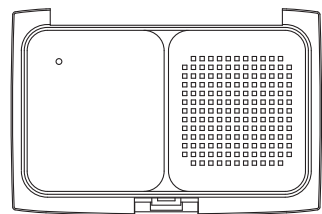
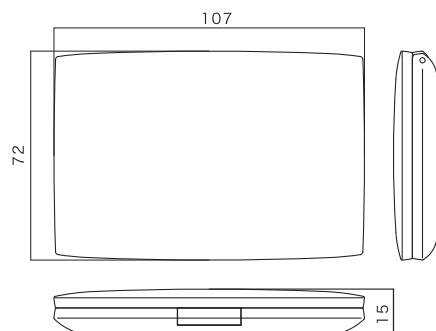

2 No.17(L)2パーツ

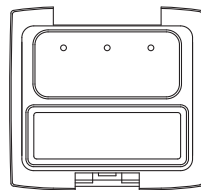
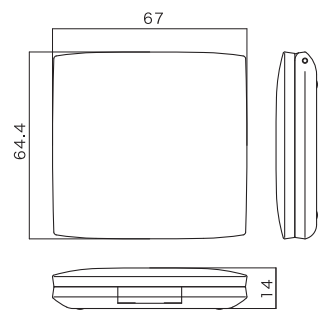

3 No.17(S)1パンA

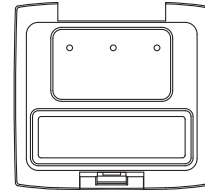

4 No.17(S)1パンB

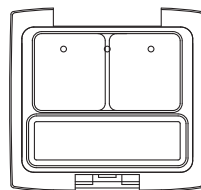

5 No.17(S)2パン

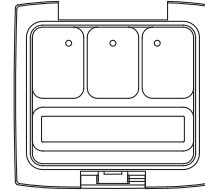

6 No.17(S)3パン

	製品名	材質	樹脂・アルミ皿サイズ(OF cc)	備考
1	No.17(L)1パーツ	フタ・本体・(ABS)・ボタン(PP)	46.8×55×5t(9.9cc)	通気穴有・無
2	No.17(L)2パーツ	天板(AS/ABS)フタ・本体(ABS)・ボタン(PP)	46.8×55×5t(9.9cc)	通気穴有・無
3	No.17(S)1パンA	天板(AS/ABS)フタ・本体・中枠(ABS)・ボタン(PP)	49.2×22.4×4.5t(4cc)	
4	No.17(S)1パンB	天板(AS/ABS)フタ・本体・中枠(ABS)・ボタン(PP)	40×23.6×4.3t(3.8cc)	
5	No.17(S)2パン	天板(AS/ABS)フタ・本体・中枠(ABS)・ボタン(PP)	26.5×24×4.5t(2.8cc)	
6	No.17(S)3パン	天板(AS/ABS)フタ・本体・中枠(ABS)・ボタン(PP)	24×17×3.4t(1.4t)	

※状況に応じて内容を変更する場合があります。